

Benennung ZUGSTANGE M12xxxx M MONT EA / TA	Klass.-Nr. 19009911	Feingliederung Bremsgestänge M12 / 170, 90 mm	Bearb.: Gerst. Datum:09.10.14	Blatt 1	Format A3	WN-Katalog 4.2	Register Gruppe 3 Chassis
--	------------------------	---	----------------------------------	------------	--------------	-------------------	------------------------------

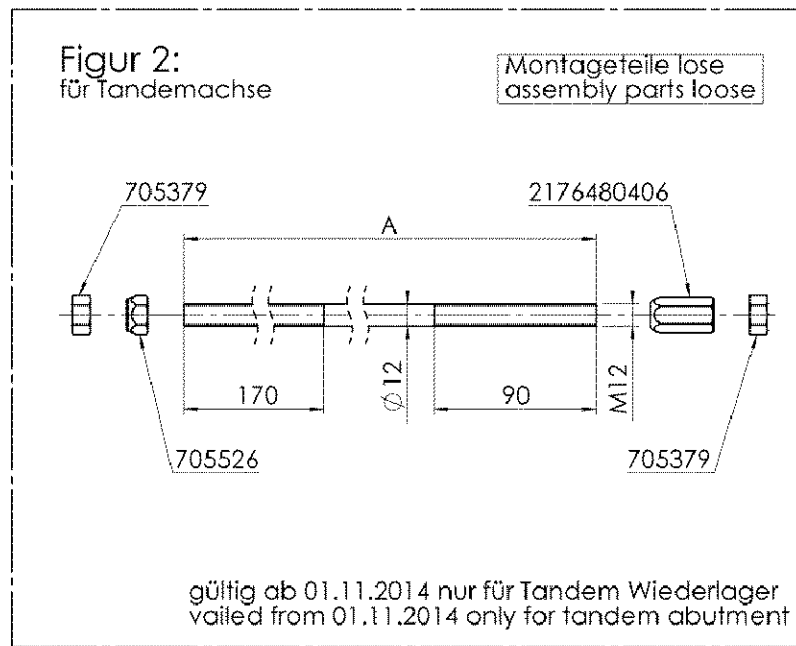
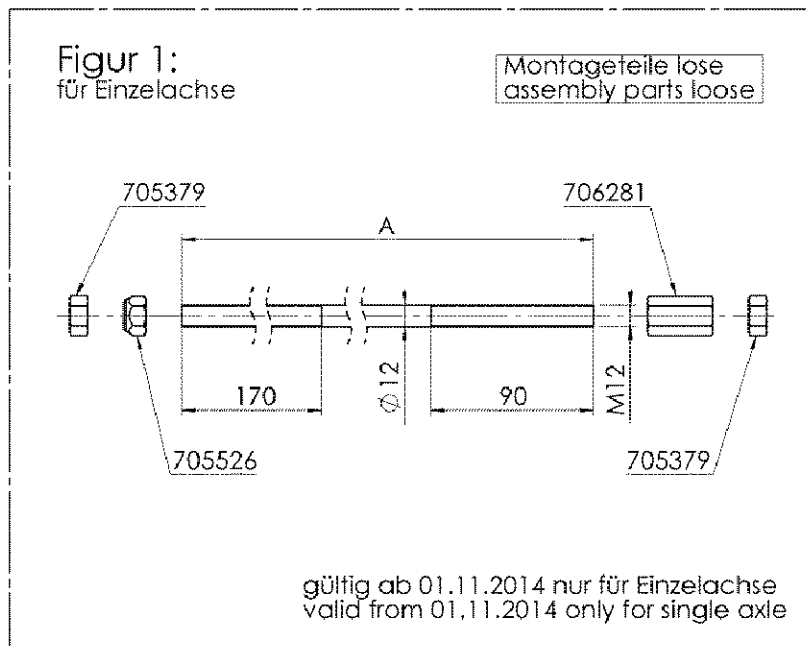

Materialnummer	Rev	A-Nr.	Änderungstext	Datum	Name
----------------	-----	-------	---------------	-------	------

Kennbuchstabe Benennung	Material-Nr.	FIG	REV	A	B	C	D
				Länge mm	Datum tt.mm.ff	Name Text	Tab \$
1		1	-	1550			\$
2		1	-	1600			\$
3		1	-	1650			\$
4		1	-	1700			\$
5		1	-	1750			\$
6		1	-	1800			\$
7		1	-	1850			\$
8		1	-	1900			\$
9	1730516	1	-	1975	09.10.14	Gerst	\$
10		1	-	2000			\$
11		1	-	2100			\$
12		1	-	2100			\$
13		1	-	2200			\$
14		1	-	2200			\$
15		1	-	2250			\$
16		1	-	2300			\$
17		1	-	2400			\$
18		1	-	2400			\$
19	1730517	1	-	2450	09.10.14	Gerst	\$
20		1	-	2500			\$
21		1	-	2600			\$
22		1	-	2600			\$
23		1	-	2700			\$
24		1	-	2700			\$
25		1	-	2800			\$
26		1	-	2800			\$
27		1	-	2900			\$
28		1	-	2900			\$
29	1730518	1	-	2950	09.10.14	Gerst	\$
30		1	-	3000			\$
	1732569	1	-	3075	31.10.18	Kraus	\$
31		1	-	3100			\$
32		1	-	3200			\$
33		1	-	3300			\$
34		1	-	3400			\$
35		1	-	3500			\$
36		1	-	3600			\$
37		1	-	3650			\$
38		1	-	3700			\$
39		1	-	3800			\$
40		1	-	3900			\$
41	1730519	1	-	4000	09.10.14	Gerst	\$

Kennbuchstabe Benennung	Material-Nr.	FIG	REV	A	B	C	D
				Länge mm	Datum tt.mm.ff	Name Text	Tab \$
1	1731286	2	-	1550	22.11.16	Kraus	\$
2		2	-	1600			\$
3		2	-	1650			\$
4		2	-	1700			\$
5		2	-	1750			\$
6		2	-	1800			\$
7		2	-	1850			\$
8		2	-	1900			\$
9	240126	2	-	1975			\$
10		2	-	2000			\$
11		2	-	2100			\$
12		2	-	2100			\$
13	1733061	2	-	2125	24.09.20	Kraus	\$
14	1732722	2	-	2200	28.02.19	Ewald	\$
15		2	-	2250			\$
16		2	-	2300			\$
17		2	-	2400			\$
18		2	-	2400			\$
19	240127	2	-	2450			\$
20		2	-	2500			\$
21		2	-	2600			\$
22		2	-	2600			\$
23		2	-	2700			\$
24		2	-	2700			\$
25		2	-	2800			\$
26		2	-	2800			\$
27		2	-	2900			\$
28		2	-	2900			\$
29	240128	2	-	2950			\$
30		2	-	3000			\$
31		2	-	3100			\$
32		2	-	3200			\$
33		2	-	3300			\$
34		2	-	3400			\$
35	1732983	2	-	3500	25.02.20	Kraus	\$
36	1730650	2	-	3600	30.01.15	Ewald	\$
37		2	-	3650			\$
38	1731071	2	-	3700	06.06.16	Kraus	\$
39		2	-	3800			\$
40		2	-	3900			\$
41	240129	2	-	4000			\$

Schutzvermerk nach DIN ISO 16016 beachten!!!

ausgegeben von: KELLERC 29.07.2021 11:52:21

freigegeben